

vtech[®]

User's Manual

Go!Go! Smart Wheels[®]
Playtime with miles of learning![™]

Chug & Go Railroad[™]

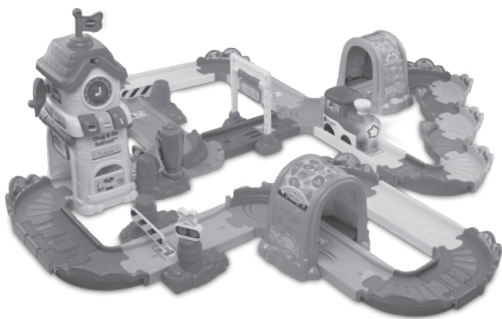

© 2015 VTech
Printed in China
91-003112-000^{US}

Dear Parent,

Welcome to the world of **Go! Go! Smart Wheels**®! We're excited you've decided to ride along with us and explore all that **Go! Go! Smart Wheels**® has to offer. These toys have been designed to give your child a thrilling learning experience with hours and hours of fun as well.

Go! Go! Smart Wheels® features vehicles that interact with your child by lighting up, singing and talking, while teaching your child letters and vehicle names (each sold separately). There are other surprises in store, too! With our innovative **SmartPoint**® technology, available on **Go! Go! Smart Wheels**® playsets (each sold separately), your child will smile as they hear **SmartPoint**® vehicles respond to each unique **SmartPoint**® location with singing, sound effects and fun phrases.

Our **Go! Go! Smart Wheels**® playsets also feature buttons, gears and other mechanical features to encourage the development of your child's fine motor skills. Many of the playsets also have tracks that can be arranged in endless ways, stimulating your child's creativity. In addition, all the **Go! Go! Smart Wheels**® playsets connect to other playsets in the collection, so there's no end to what your child can do!

With **Go! Go! Smart Wheels**®, it's playtime with miles of learning!

Sincerely,
Your friends at **VTech**®

To learn more about **VTech**® toys, visit vtechkids.com

INTRODUCTION

Thank you for purchasing the **VTech® Go! Go! Smart Wheels® Chug & Go Railroad™!**

All aboard the **Go! Go! Smart Wheels® Chug & Go Railroad™!** Watch the train chug under tunnels and through the electronic train station with the motorized **SmartPoint®** train.

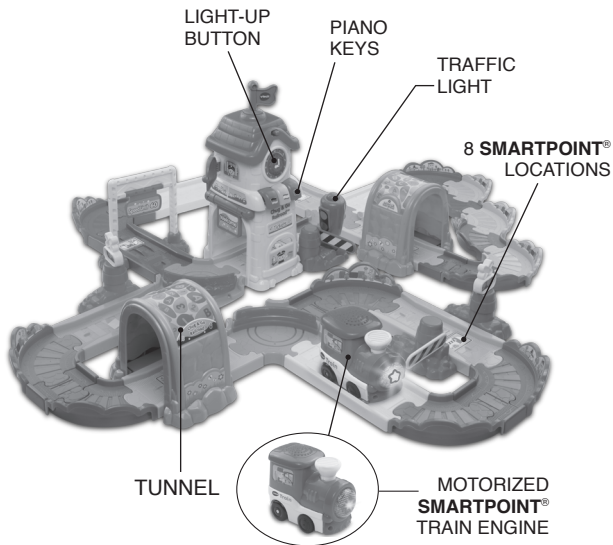

INTRODUCTION

(*Slide the switch to turn on the train's motor.)

INCLUDED IN THIS PACKAGE



One motorized
SmartPoint® train



One electronic train station
with one **SmartPoint®** track



Two tunnels



Two **SmartPoint®**
straight tracks with
traffic lights



One **SmartPoint®**
straight track with
road sign

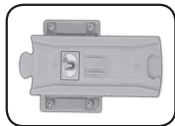

Two **SmartPoint®**
tunnel tracks



One traffic light

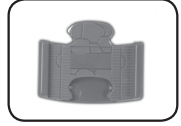

Seven 1/4
straight tracks

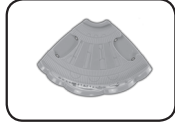

Seven 90-degree
tracks, female

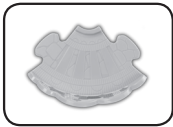

Seven 90-degree tracks,
male

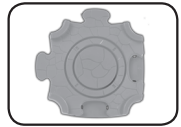

Three cross
tracks



Two curved pieces
for the cross tracks
(change direction)

INCLUDED IN THIS PACKAGE



One gate railing with base for station



Two **SmartPoint**® straight tracks



Two straight tracks

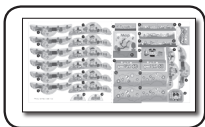

One label sheet

- One user's manual

WARNING: All packing materials, such as tape, plastic sheets, packaging locks and tags are not part of this toy, and should be discarded for your child's safety.

ATTENTION: Pour la sécurité de votre enfant, débarrassez-vous de tous les produits d'emballage tels que rubans adhésifs, feuilles de plastique, attaches et étiquettes. Ils ne font pas partie du jouet.

NOTE: Please keep this user's manual as it contains important information.

WARNING: For your child's safety, only use the motorized train on Go! Go! Smart Wheels®, Go! Go! Smart Animals® and Go! Go! Smart Friends® playsets. Do not roll the train on your clothing, body or hair while the motorized train is turned on. If something gets caught in the train's wheels while the motor is on, lift the train up so it is no longer touching your child or slide the mode selector switch to the off position to turn off the motor.

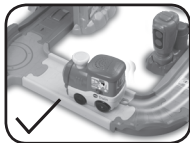

INCLUDED IN THIS PACKAGE

Please adhere the labels to the playset securely as indicated on the following page:

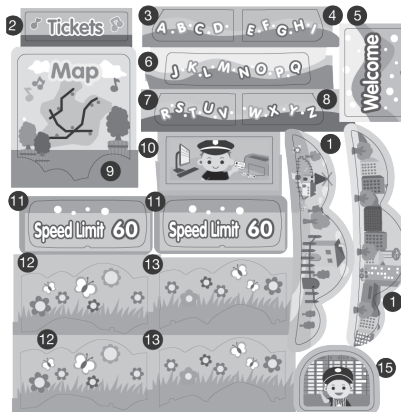
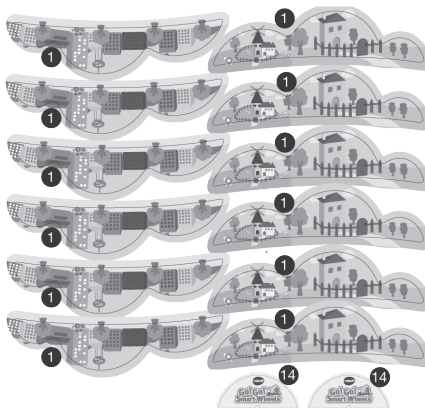

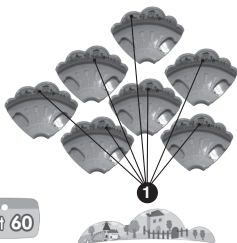
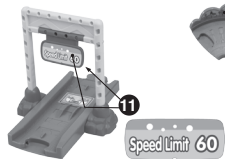
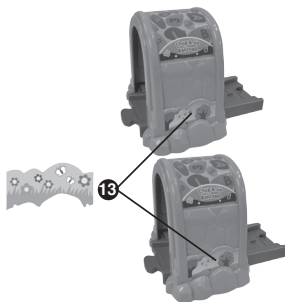
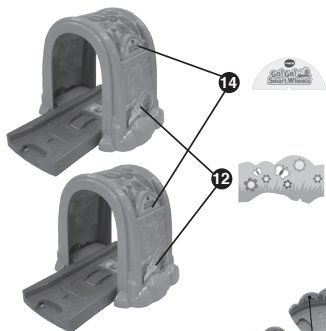
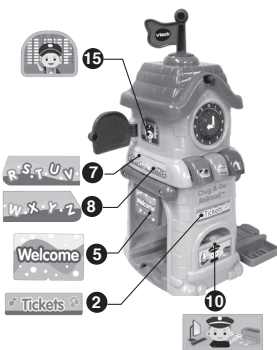
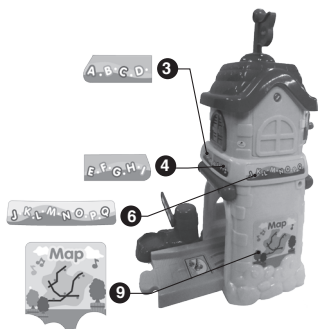

GETTING STARTED

BATTERY INSTALLATION - TRAIN

1. Make sure the unit is turned **OFF**.
2. Locate the battery cover on the bottom of the unit. Use a screwdriver to loosen the screw.
3. Install 3 new AAA (AM-4/LR03) batteries following the diagram inside the battery box. (The use of new alkaline batteries is recommended for maximum performance.)
4. Replace the battery cover and tighten the screw to secure.

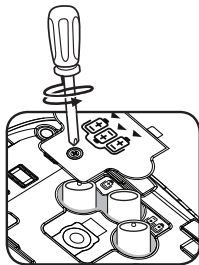

BATTERY INSTALLATION – STATION

1. Make sure the unit is turned **OFF**.
2. Locate the battery cover on the back of the station. Use a coin or a screwdriver to loosen the screw.
3. Install 2 new 'AAA' (AM-4/LR03) batteries following the diagram inside the battery box. (The use of new alkaline batteries is recommended for maximum performance.)
4. Replace the battery cover and tighten the screw to secure.

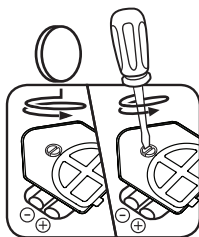

BATTERY NOTICE

- Use new alkaline batteries for maximum performance.
- Use only batteries of the same or equivalent type as recommended.
- Do not mix different types of batteries: alkaline, standard (carbon-zinc) or rechargeable (Ni-Cd, Ni-MH), or new and used batteries.
- Do not use damaged batteries.
- Insert batteries with the correct polarity.

- Do not short-circuit the battery terminals.
- Remove exhausted batteries from the toy.
- Remove batteries during long periods of non-use.
- Do not dispose of batteries in fire.
- Do not charge non-rechargeable batteries.
- Remove rechargeable batteries from the toy before charging (if removable).
- Rechargeable batteries are only to be charged under adult supervision.

ASSEMBLY INSTRUCTIONS

With the VTech® Go! Go! Smart Wheels® Chug & Go Railroad™, safety comes first. To ensure your child's safety, adult assembly is required.

ELECTRONIC STATION

1. Attach the gate railing base to the **SmartPoint**® track of the electronic station. You will hear a "click" sound to indicate the track is secure.

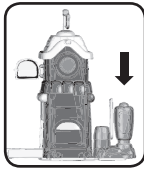
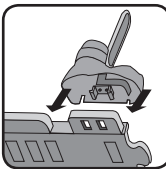

2. Place the traffic light on the gate railing.

TUNNEL

1. Attach the tunnel to the **SmartPoint**® tunnel track. You will hear a "click" sound to indicate the track is secure.

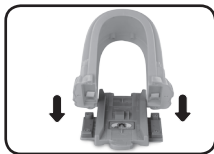

After the above steps, connect these pieces to the included track pieces. You can configure them into different arrangements.

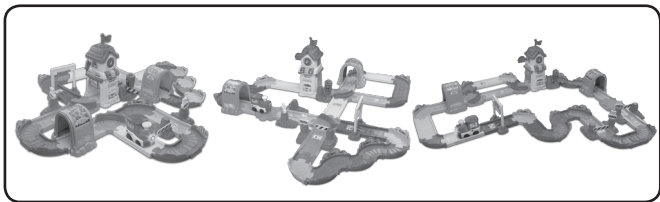

PRODUCT FEATURES - TRAIN

1. OFF/MODE SELECTOR SWITCH

To turn the unit **ON**, slide the **OFF/MODE SELECTOR SWITCH** to the **Motor Play Mode (MOTOR)** or **Manual Play Mode (⏻)** position. To turn the unit **OFF**, slide the **OFF/MODE SELECTOR SWITCH** to the **OFF (●)** position.

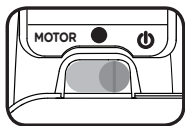



2. AUTOMATIC SHUT-OFF

To preserve battery life, the motorized train will automatically power-down after approximately 30 seconds without input while the motor is off. The unit can only be turned on again by pressing the light-up button or pushing the train quickly.

ACTIVITIES - TRAIN

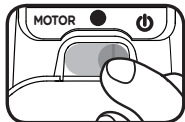
1. Slide the **OFF/MODE SELECTOR SWITCH** to turn the unit **ON**. You will hear train sounds, a song and a phrase. The train will move forward automatically when it's in **Motor Play Mode** (Note: The train's back wheels need to be on a firm surface in order to trigger the motor.) The light will flash with the sounds.



- 
- In **Motor Play Mode**, the motor will stop automatically two seconds after you remove the train from the tracks. The motor will restart once the train is put back down.
 - Press the **LIGHT-UP BUTTON** to hear train sounds, songs and phrases. Press and hold the **LIGHT-UP BUTTON** to stop the motor while in the **Motor Play Mode**. The motor will restart after the button is released. The light will flash with the sounds.
 - While in the **Manual Play Mode**, push the train over the 8 **SmartPoint**[®] locations included in the playset to hear greetings, fun sounds, short tunes and sing-along songs. The light will flash with the sounds. The train also interacts with **SmartPoint**[®] locations on other **Go! Go! Smart Wheels**[®] and **Go! Go! Smart Animals**[®] playsets (each sold separately). The light will flash with the sounds.
 - While in the **Motor Play Mode**, let the train run through the **SmartPoint**[®] locations to hear greetings, fun sounds, short tunes and sing-along songs. The light will flash with the sounds.
 - While the motor is off, if there is no input after approximately 8 seconds, you will hear an invitation and a sound effect. After another 8 seconds of no input, a song will play. If there is no input for an additional 8 seconds, the unit will play a short tune and then go into sleep mode. While the motor is running, you'll hear the train whistle, then the train will enter sleep mode after 5 minutes of no input. The train can be re-activated by pressing the light-up button or pushing the train quickly.





SING-ALONG SONG LYRICS

SONG 1

My train is ready,
Let's start our journey!
Choo, choo, toot, toot.
Chug along with me!

SONG 2

My train is so powerful.
Chugging along is wonderful!

SONG 3

Carrying cars short and long,
My train is really strong!

MELODY LIST:

1. I've Been Working on the Railroad
2. Jack & Jill
3. It's Raining, It's Pouring
4. Old King Cole
5. London Bridge
6. Hey Diddle Diddle
7. Polly Wolly Doodle
8. Humpty Dumpty
9. Here We Go 'Round the Mulberry Bush
10. The Glow Worm
11. This Old Man
12. Hickory Dickory Dock
13. Frère Jacques
14. Pop! Goes the Weasel
15. Hot Cross Buns
16. Pease Porridge Hot
17. Alouette

PRODUCT FEATURES – TRAIN STATION

1. OFF/VOLUME CONTROL SWITCH

To turn the unit **ON**, slide the **OFF/VOLUME CONTROL SWITCH** to the **Low** (🔊) or the **High** (🔊) volume position. To turn the unit **OFF**, slide the **OFF/VOLUME CONTROL SWITCH** to the **OFF** (🔇) position.

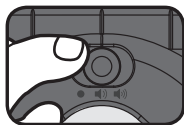

2. AUTOMATIC SHUT-OFF

To preserve battery life, the electronic train station will automatically power-down after approximately 30 seconds without input. The unit can be turned on again by pressing any button.

ACTIVITIES - TRAIN STATION

1. Slide the **OFF/VOLUME CONTROL SWITCH** to turn on the electronic train station. You will hear a song and a greeting. The light will flash with the sounds.

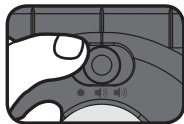

2. Press the **LIGHT-UP BUTTON** to hear clock sounds, songs, phrases and a short tune. The light will flash with sounds.

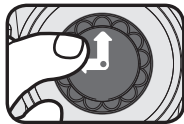

3. Press the **COLOR BUTTONS** to learn colors and hear phrases in English, German, Spanish and French with fun sounds, phrases and short tunes. The light will flash with sounds.

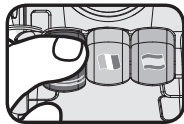

4. Push the train or let the train run through the station to activate the **SWINGING BOARD**. You'll hear fun sounds and greetings in different languages. The light will flash with sounds.



5. If there is no input after approximately 10 seconds, you will hear a sound effect and a reminder that the train is coming. After another 10 seconds of no input, the unit will play a short tune and then go into sleep mode. The unit can be re-activated by pressing any button.

SING-ALONG SONG LYRICS

SONG 1

Welcome to the station, here comes the train.
Rolling here, rolling there, rolling everywhere!
Toot-toot, chug-chug, hello, train!

SONG 2

Chug-chug, toot-toot,
The train is coming!
Hello, hello,
Have your tickets ready!

CARE & MAINTENANCE

1. Keep the unit clean by wiping it with a slightly damp cloth.
2. Keep the unit out of direct sunlight and away from any direct heat source.
3. Remove the batteries when the unit will not be in use for an extended period of time.
4. Do not drop the unit on hard surfaces and do not expose the unit to moisture or water.



TROUBLESHOOTING

If for some reason the program/activity stops working or malfunctions, please follow these steps:

1. Please turn the unit **OFF**.
2. Interrupt the power supply by removing the batteries.
3. Let the unit stand for a few minutes, then replace the batteries.
4. Turn the unit **ON**. The unit should now be ready to play again.
5. If the product still does not work, replace with a new set of batteries.

If the problem persists, please call our Consumer Services Department at 1-800-521-2010 in the U.S. or 1-877-352-8697 in Canada, and a service representative will be happy to help you.

For information on this product's warranty, please call **VTech**® at 1-800-521-2010 in the U.S. or 1-877-352-8697 in Canada.

IMPORTANT NOTE:

Creating and developing **Infant Learning** products is accompanied by a responsibility that we at **VTech**® take very seriously. We make every effort to ensure the accuracy of the information which forms the value of our products. However, errors sometimes can occur. It is important for you to know that we stand behind our products and encourage you to call our Consumer Services Department at 1-800-521-2010 in the U.S. or 1-877-352-8697 in Canada with any problems and/or suggestions that you might have. A service representative will be happy to help you.



NOTE:

This equipment has been tested and found to comply with the limits for a Class B digital device, pursuant to Part 15 of the FCC Rules. These limits are designed to provide reasonable protection against harmful interference in a residential installation. This equipment generates, uses and can radiate radio frequency energy and, if not installed and used in accordance with the instructions, may cause harmful interference to radio communications. However, there is no guarantee that interference will not occur in a particular installation. If this equipment does cause harmful interference to radio or television reception, which can be determined by turning the equipment off and on, the user is encouraged to try to correct the interference by one or more of the following measures:

- Reorient or relocate the receiving antenna.
- Increase the separation between the equipment and receiver.
- Connect the equipment into an outlet on a circuit different from that to which the receiver is connected.
- Consult the dealer or an experienced radio/TV technician for help.

Caution : changes or modifications not expressly approved by the party responsible for compliance could void the user's authority to operate the equipment.

THIS DEVICE COMPLIES WITH PART 15 OF THE FCC RULES. OPERATION IS SUBJECT TO THE FOLLOWING TWO CONDITIONS: (1) THIS DEVICE MAY NOT CAUSE HARMFUL INTERFERENCE, AND (2) THIS DEVICE MUST ACCEPT ANY INTERFERENCE RECEIVED, INCLUDING INTERFERENCE THAT MAY CAUSE UNDESIRE OPERATION.

CAN ICES-3 (B)/NMB-3(B)



vtech®

PRODUCT WARRANTY

This Warranty is applicable only to the original purchaser, is non-transferable and applies only to "VTech" products or parts. This product is covered by a 3-month Warranty from the original purchase date, under normal use and service, against defective workmanship and materials. This Warranty does not apply to (a) consumable parts, such as batteries; (b) cosmetic damage, including but not limited to scratches and dents; (c) damage caused by use with non-VTech products; (d) damage caused by accident, misuse, unreasonable use, immersion in water, neglect, abuse, battery leakage, or improper installation, improper service, or other external causes; (e) damage caused by operating the product outside the permitted or intended uses described by VTech in the owner's manual; (f) a product or part that has been modified (g) defects caused by normal wear and tear or otherwise due to the normal aging of the product; or (h) if any VTech serial number has been removed or defaced.

Prior to returning a product for any reason, please notify the VTech Consumer Services Department, by sending an email to vtechkids@vtechkids.com or calling 1-800-521-2010. If the service representative is unable to resolve the issue, you will be provided instructions on how to return the product and have it replaced under Warranty. Return of the product under Warranty must adhere to the following rules:

If VTech believes that there may be a defect in the materials or workmanship of the product and can confirm the purchase date and location of the product, we will at our discretion replace the product with a new unit or product of comparable value. A replacement product or parts assumes the remaining Warranty of the original product or 30 days from the date of replacement, whichever provides longer coverage.

THIS WARRANTY AND THE REMEDIES SET FORTH ABOVE ARE EXCLUSIVE AND IN LIEU OF ALL OTHER WARRANTIES, REMEDIES AND CONDITIONS, WHETHER ORAL, WRITTEN, STATUTORY, EXPRESS OR IMPLIED. IF VTECH CANNOT LAWFULLY DISCLAIM STATUTORY OR IMPLIED WARRANTIES THEN TO THE EXTENT PERMITTED BY LAW, ALL SUCH WARRANTIES SHALL BE LIMITED TO THE DURATION OF THE EXPRESS WARRANTY AND TO THE REPLACEMENT SERVICE AS DETERMINED BY VTECH IN ITS SOLE DISCRETION.

To the extent permitted by law, VTech will not be responsible for direct, special, incidental or consequential damages resulting from any breach of Warranty.

This Warranty is not intended to persons or entities outside the United States of America. Any disputes resulting from this Warranty shall be subject to the final and conclusive determination of VTech.